

SPECIFICATIONS

Input Voltage	AC 100V - 260V,50-60Hz
Power Consumption	35W
Battery Spec	5200 mAH,14.8 V
Charger Output Voltage	16.8 V,2A
LEDs	4 X 8Watt RGBW 4in1 LEDs
LED Life Span	50000 ~100000 hours
DMX Channels	3,4,5,8 or 9CH
Control Mode	Standalone,Mater/slave, Auto,Sound Active
Signal Input&Output	3 - pin XLR Male, 3 - pin XLR Female
Wireless	2.4G,126 channels jumping frequency automatically
IR Control	Infrared remote control up to 30 ft./ 10M .
Function Effect	Dimmer, Strobe, Eotic, Gradual Change
Refresh Rate	1.5KHz
Beam Angle	30°
Cooling Mode	Natural convection(no fan, no noise)
Protection Grade	IP20
Anti-electricity Intension	>1.5KV
Insulation Resistance	>2MΩ
Dimensions	167 X 138 X 188 mm (6.6" X 5.4" X7.4")
Weight	3.1kg (6.84lbs)

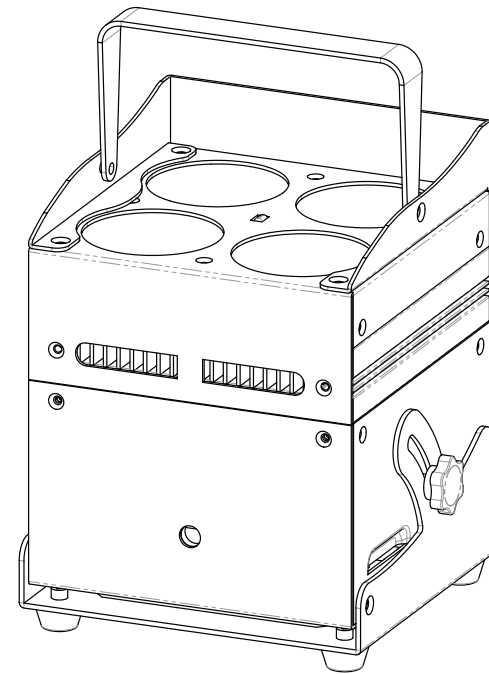

MobilePar Quad 4 CKW02-6004



USER MANUAL

TABLE OF CONTENTS

PACKAGE CONTENTS	2
SAFETY INSTRUCTIONS	3
FEATURES	4
DIMENSIONS	4
SAMPLE WIRING DIAGRAM	4
DMX TERMINATION	4
CONTROL PANEL	5
MENU SYSTEM	6
MASTER/SLAVE MODE	7
DMX CONTROL	7
PRESETS	10
IRC REMOTE	10
BATTERY	11
TROUBLESHOOTING	11
SPECIFICATIONS	12

PACKAGE CONTENTS

- 1 X LED Par Stage Light DMX wireless&battery 8-watt x 4 LEDs
- 1 X AC power cable
- 1 X User's manual
- 1 X IR controller

BATTERY

- Battery life : The battery life is 500 times charging and discharging.
- The battery specification :
Lithium battery , 5200 mAh, 18650 , 14.8V
- Charging time : 2 hours
- Battery using time :

The following table shows Battery using time after fully charged.

Battery using time after fully charged (hours)				
Single color	Two colors mixing	Three colors mixing	Full color	Color jumping change
9.5 ~ 10.5	5.5	3.5	3	7 ~ 8

TROUBLESHOOTING

Following are some sample problems and potential solutions to those problems.

Q1: The light does not turn on and the menu will not display.

A1: Check the power cable to ensure it is properly plugged in. Check the source power outlet by plugging in a different device.

Q2: The light will not turn on, but the menu does display.

A2: Using the menu, ensure that the color dimmers are not all set to 000.

Q3: The light does not respond to DMX commands.

A3: Ensure that the light is set to DMX mode with a valid DMX address. Check for address conflicts with other devices. Check the cabling to ensure that there is continuity between the light and the DMX controller. Verify that there is a terminator at the end of the chain. Verify that the DMX controller is operating properly with another DMX device.

PRESETS

The following table describes in basic terms each of the 30 program presets built into the fixture. The SP-- value determines the speed of any color cycling, flashing, or fading.

Program	Function	Program	Function
00	Red	16	Blue Strobe
01	Green	17	White Strobe
02	Blue	18	Red + Green Strobe
03	White	19	Red + Blue Strobe
04	Red + Green	20	Red + White Strobe
05	Red + Blue	21	Green + Blue Strobe
06	Red + White	22	Blue + White Strobe
07	Green + Blue	23	Red + Green + Blue Strobe
08	Blue + White	24	Red + Blue + White Strobe
09	Red + Green + Blue	25	Green + Blue + White Strobe
10	Red + Blue + White	26	Red + Green + White Strobe
11	Green + Blue + White	27	Red + Green + Blue + White Strobe
12	Red + Green + White		
13	Red + Green + Blue + White	28	Red Strobe
14	Red Strobe	29	Red Green Blue White Color Cycling
15	Green Strobe	30	Seven color cycling

IRC REMOTE

When using IR remote controller, please turn off wireless DMX and cut off DMX connections.

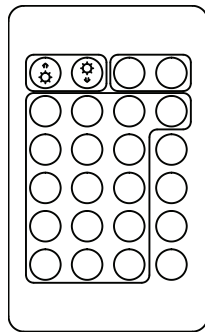

The function of each button on the remote controller is shown in below chart.

dimming +	dimming -	OFF	ON
red	green	blue	white
100%R+24%G	90%G+23%B	22%R+87%B	flash
100%R+47%G	82%G+46%B	48%R+75%B	strobe
100%R+71%G	72%G+69%B	67%R+62%B	fade
100%R+100%G	100%G+100%B	100%R+100%B	smooth

SAFETY INSTRUCTIONS



Please read these instructions carefully. They include important information about the installation, usage and maintenance of this product.

- Please keep this User Guide for future use. If you sell the unit to someone else, be sure that they also receive this User Guide.
- ALWAYS make sure that you are connecting to the proper voltage, and that the line voltage you are connecting to is not higher than that stated on the decal or rear panel of the fixture.
- This product is intended for indoor use only.
- To prevent risk of fire or shock, do not expose fixture to rain or moisture.
- Make sure there are no flammable materials close to the unit while operating.
- The unit must be installed in a location with proper ventilation, at least 20" (50cm) from adjacent surfaces. Be sure that no ventilation slots are blocked.
- ALWAYS disconnect from the power source before servicing or replacing fuse and be sure to replace with same fuse size and type.
- ALWAYS secure fixture using a safety chain. NEVER carry the fixture by its cord. Use its carrying handles.
- DO NOT operate at ambient temperatures higher than 104°F (40°C).
- In the event of a serious operating problem, stop using the unit immediately. NEVER try to repair the unit by yourself. Repairs carried out by unskilled people can lead to damage or malfunction. Please contact the nearest authorized technical assistance center. Always use the same type spare parts.
- NEVER connect the device to a dimmer pack.
- Make sure the power cord is never crimped or damaged.
- Never disconnect the power cord by pulling or tugging on the cord.
- Avoid direct eye exposure to the light source while it is on.

Caution! There are no user serviceable parts inside the unit. Do not open the housing or attempt any repairs yourself.

FEATURES

- Four 8-watt R/G/B/W 4 in 1 LEDs.
- 3,4,5,8 or 9-channel DMX modes.
- Built-in 5200 mAH lithium battery, The battery is very easy to replace.
- Built-in DMX512 wireless receiver/transmitter, adopt 2.4G ISM frequency section(global opening section) without permission limited. High effective GFSK modulate, communication design, 126 channels jumping frequency automatically, high anti-jamming ability.
- IR control: Infrared remote control up to 30 ft./ 10M .
- 32-bit smooth dimming technology, flicker free for TV and camera shooting.
- Variable electronic strobe, dimming and color changing effect.
- Stand-alone, Master/Slave and DMX modes.
- Daisy chain connections to connect additional units.

DIMENSIONS

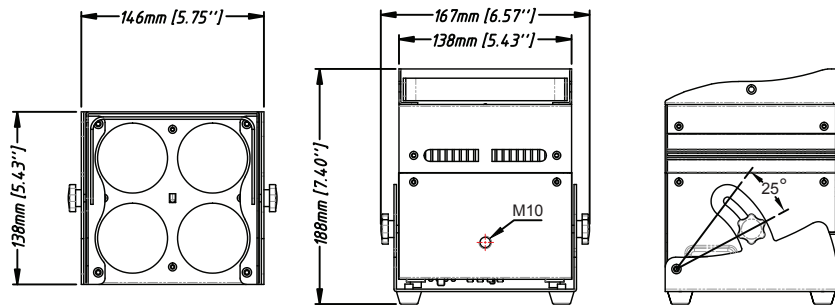

SAMPLE WIRING DIAGRAM

The following diagram shows a sample wiring chain using multiple lights. Note that as with all DMX chains, the last unit must have a DMX terminator connected to the DMX output.

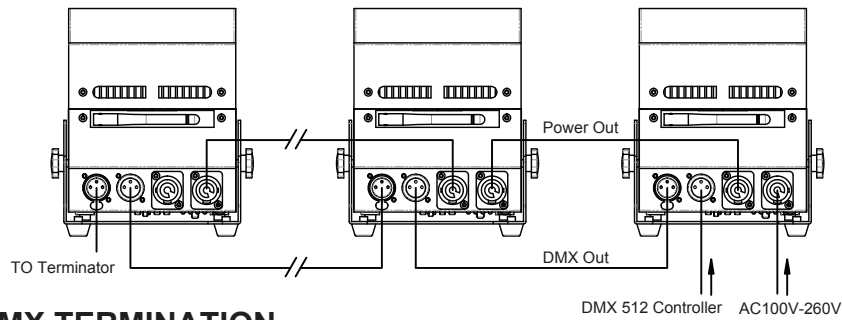

DMX TERMINATION

As with all DMX devices, the last unit in any chain must have a DMX terminator connected to the DMX output. If using just a single light, connect a DMX terminator to the DMX output.

A DMX terminator is a DMX plug with a 120-ohm, 1/4-watt resistor soldered between pins 2 and 3.



9CH Mode

CHANNEL	VALUE	FUNCTION	PRIORITY	REMARKS
1	000-255	General dimming 0-100%	1	
2	000-255	Red dimming 0-100%		
3	000-255	Green dimming 0-100%		
4	000-255	Blue dimming 0-100%		
5	000-255	White dimming 0-100%		
6	000-014	Not used	2	
	015-255	Strobe (fast - slow)		
7	000-031	Not used	3	Must use channels 1-6 to get light. Channel 9 is speed adjustment.
	032-063	Dark - bright		
	064-095	Bright - dark		
	096-127	Dark -bright - dark		
	128-159	Fade		
	160-191	Dark -bright - dark (auto run)		
	192-223	Color flash change		
224-255	Sound activated			
8	000-255	Speed adjustment		Slow - fast
9	000-005	Uses the "nodE" setting		Similar to the "nodE" setting, but with variable speed control. DIMMER0 has the fastest range, DIMMER4 the slowest. Dependent on use of channels 1-7.
	006-055	DIMMING 0		
	056-105	DIMMING 1		
	106-155	DIMMING 2		
	155-205	DIMMING 3		
	205-255	DIMMING 4		

5CH Mode

CHANNEL	VALUE	FUNCTION	PRIORITY	REMARKS
1	000-255	General dimming 0-100%		
2	000-255	Red dimming 0-100%		
3	000-255	Green dimming 0-100%		
4	000-255	Blue dimming 0-100%		
5	000-255	White dimming 0-100%		

8CH Mode

CHANNEL	VALUE	FUNCTION	PRIORITY	REMARKS
1	000-255	General dimming 0-100%	1	
2	000-255	Red dimming 0-100%		
3	000-255	Green dimming 0-100%		
4	000-255	Blue dimming 0-100%		
5	000-255	White dimming 0-100%		
6	000-014	Not used	2	
	015-255	Strobe (fast - slow)		
7	000-031	Not used	3	Must use channels 1-6 to get light. Channel 9 is speed adjustment.
	032-063	Dark - bright		
	064-095	Bright - dark		
	096-127	Dark -bright - dark		
	128-159	Fade		
	160-191	Dark -bright - dark (auto run)		
	192-223	Color flash change		
224-255	Sound activated			
8	000-255	Speed adjustment		Slow - fast

CONTROL PANEL

1. WIRELESS DMX

The fixture Built-in DMX512 wireless receiver/transmitter,adopt 2.4G ISM frequency section(global opening section) without permission limited. High effective GFSK modulate,communication design ; 126 channels jumping frequency automatically, high anti-jamming ability.

- The setting of receiving wireless DMX

- Delete connection with other transmitter: Press the button and hold for over 3 seconds until the indicator turns white.
- Connection: Press the button on the transmitter, the fixture will be connected and the green light will stop flashing.

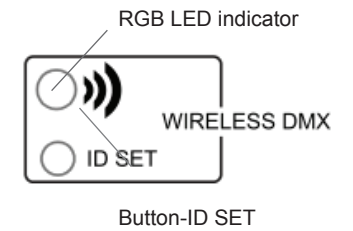

Note: Receiver could only be connected to the new transmitter after the old connection is deleted.

- Working condition:

LED constant lit up: no DMX or wireless signal.
Green LED flash: receiveing.

2. MIC

Rotate knob can adjust the sensitivity of the built-in microphone.

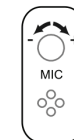

3. BATTERY SOC

Press the button, can display the remaining power of the battery.

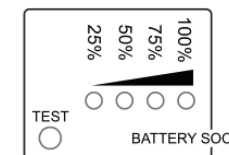

MENU SYSTEM

Use the four buttons under the LED display on the back to set the mode in which the light will operate. The buttons perform the following functions:

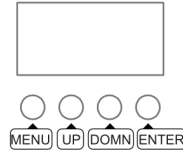

MENU: Accesses the menu system or backs out of editing an entry.

UP: Selects the previous mode or increases the value of the selected mode.

DOWN: Selects the next mode or decreases the value of the selected mode.

ENTER: Selects the currently displayed mode for editing or accepts the edited value.

The following table shows the menu options, their possible values, and what they mean.

ENTRY	VALUES	REMARKS
Addr	d001-d255	DMX address
CHnd	3,4,5,8,9CH	DMX channel selection
SLAU	SL.AU	Slave mode
SP- -	SP00-SP15	Program speed (fast-slow)
Pr- -	Pr00-Pr30	Preset selection
ASC-	AC00-AC15	Color jump
FAdE	FA00-FA15	Color fade (fast-slow)
FLAS	FL00-FL15	Strobe mode (fast-slow)
rL- -	r000-r255	Red dimming
GL- -	G000-G255	Green dimming
bL- -	b000-b255	Blue dimming
UL- -	U000-U255	White dimming
SoUA	So.UA	Sound activation mode on/off
LEd	on/oFF	LED display on/auto off (after about 2 minutes)
nodE	nod0-nod4	Speed limiter (see “nodE” section for details)
UEm	UE2.0	Displays the software version number

“nodE”

The “nodE” function serves as a speed limiter for manual dims and fades. When set to “nod0”, any manual dims or fades will be in real time, meaning that light will dim or fade as fast as you move the slider on the controller. The other “nodE” values (1-4) are progressively slower than real time.

Note that this functionality is expanded in channel 10 of the 10-channel DMX control mode.

MASTER/SLAVE MODE

Whenever the light is set to a mode other than a DMX address or Slave mode, it is considered to be in Master mode. For example, when set to the Sound Activated operation, it is in a Master mode.

When the light is the Master, it will send DMX instructions to other connected lights. Those other lights must be set to Slave mode (SLAU) to receive and execute the instructions sent by the Master light.

NOTE: Only one light in any DMX Universe can be the Master. All other lights in the chain must be set to Slave mode (SLAU).

DMX CONTROL

When the light is set to a DMX address it will respond to signals from a DMX controller. The number and complexity of the signals it can respond to correspond directly to the number of channels selected. The following tables show the functions and values for each channel in the four different channel modes (3,4,5,8 or 9).

3CH Mode

CHANNEL	VALUE	FUNCTION	PRIORITY	REMARKS
1	000-255	RGB color mixing		tonal
2	000-255	White dimming 0-100%		saturation
3	000-255	General dimming 0-100%		purity

4CH Mode

CHANNEL	VALUE	FUNCTION	PRIORITY	REMARKS
1	000-255	Red dimming 0-100%		
2	000-255	Green dimming 0-100%		
3	000-255	Blue dimming 0-100%		
4	000-255	White dimming 0-100%		